

**USER'S MANUAL**  
**"IRIS"**  
**TILT SWITCH AND CONTROLLER**

Serial No. \_\_\_\_\_

- High-Gain Version ( $\pm 10$  degrees)
- Standard Version ( $\pm 25$  degrees)
- Wide-Angle Version ( $\pm 50$  degrees)



850 Perimeter Road  
Manchester, NH 03103 USA  
Tel (603) 669-6400  
Fax (603) 622-2690  
sales@jewellinstruments.com  
www.jewellinstruments.com

The **IRIS Tilt Switch and Controller** is a powerful control device that enables you to measure and respond to rotational movements in any direction with reference to the unchanging gravity vector. Use **IRIS** to maintain platform levelness, avoid tipover conditions, prevent out-of-range movement, and for many other control requirements.

**IRIS** detects angular position with an on-board electrolytic tilt sensor, which has no mechanical moving parts to break or wear out. The standard firmware includes five user-programmable set points for tilts in different directions. When a selected threshold is reached, the circuitry sets the output high on one of the pins in the H3 control connector. Three additional control outputs are available for firmware upgrades in custom applications.

**IRIS** is also a multi-featured inclinometer, which contributes to its powerful control capabilities. Data sampling rates, which are also the threshold checking rates, are user-selectable, and inclination data in ASCII

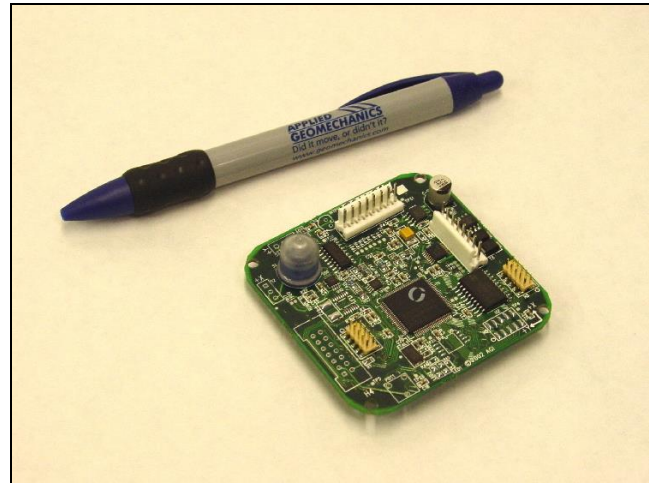

format can be continuously output to external devices. Firmware commands include averaging, autozero and other powerful functions. **Call us for details or to place an order!**

	High-Gain Version	Standard Version	Wide-Angle Version
ANGULAR RANGE	±10 degrees (20 degree span)	±25 degrees (50 degree span)	±50 degrees* (100 deg. span)
RESOLUTION	0.005 degree	0.012 degree	0.025 degree
ACCURACY	±1% of full span		
TIME CONSTANT, T	150 msec; output is proportional to $1 - e^{-t/T}$ where $t$ = time in seconds		
NATURAL FREQUENCY	7 Hz; available with viscous sensor to filter vibrations		
TEMPERATURE COEF.	Span: +0.03%/°C, Zero: 10-20 arc sec/°C typical		
SAMPLE RATES	User-selectable from 10/second to 1/hour		
DATA STORAGE	512 kB of nonvolatile Flash Memory available as an option		
SERIAL OUTPUT	RS232 or RS422(485), full duplex. Baud rate: 9600 (default), 19200, 28800, 57600, 115200, 230400		
DATA FORMATS	Formats: NMEA XDR, Trimble proprietary, Ashtech compatible, Simple (x, y, temperature, serial number)		
CONTROL OUTPUTS	8 TTL-compatible CMOS control outputs (0-5 VDC): 5 with user-programmable set points, 3 available for custom applications. Each channel can source up to 20 mA, not to exceed 100 mA for all 8 channels.		
POWER REQUIREMENTS	7-28 VDC @ 27 mA, 250 mV peak-to-peak ripple max., reverse polarity and surge protected.		
ENVIRONMENTAL	-40° to +85°C operating and storage; 90% humidity, noncondensing		
CONNECTIONS	Three 60cm (2 ft) cables included: Signal (H1), Power (H2), Control Outputs (H3)		
DIMENSIONS & WEIGHT	67 x 67 x 25mm max. (2.6 x 2.6 x 1.0 inches); 31g (1.1 oz)		

\*greater range available

IRIS Tilt Switch Order Numbers		
Version	RS232	RS422(485)
High Gain	98021-03	98021-09
Standard	98021-01	98021-07
Wide Angle	98021-02	98021-08

Accessories & Upgrades	Part No.
Power Kit: 100-240 VAC wall transformer, power cable with connectors	84091
Critically damped sensor to filter vibrations	VISCDAMP
Mounting plate & hardware	84089
512 kB Flash memory upgrade	48543

## A Full-Featured Inclinometer

**IRIS** is a versatile biaxial clinometer that measures rotational movement in two orthogonal vertical planes. Serial ASCII data are output as either RS232 or RS422(485) signals for recording by an external terminal or computer. Important features are firmware-controlled and user-selectable. These include output data rates and formats, signal averaging, autozero (nulling), and internal data storage (logging). Several output data formats are provided, all of which include X tilt, Y tilt, Temperature and Serial Number information.

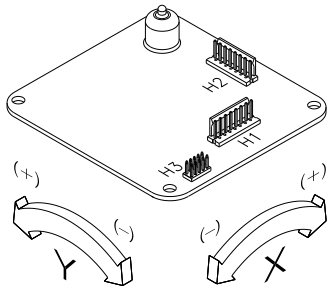

## A Powerful Control Device

The firmware on the standard IRIS board has 5 user programmable thresholds. When a tilt measurement is taken, it is compared to each of these thresholds: +X tilt, -X tilt, +Y tilt, -Y tilt and tilt in any direction. If the measurement exceeds one or more of the thresholds, the corresponding output pin(s) in the H3 connector, are set high (5V), as shown below. If the threshold is not exceeded, the output remains at 0 Volts. The reference angle for the threshold measurement is selected using the autozero command. Threshold checking may be turned off with a single firmware command when it is not needed.

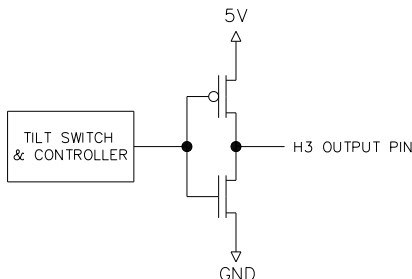

The standard **IRIS** firmware also allows the user to set the *hysteresis* of the control thresholds. The hysteresis is used as follows: After an H3 output pin is set high, it is not set low again until the tilt reading has reached a

level that is below the threshold by an amount equal to the hysteresis (see diagram).

**IRIS** includes 3 additional control output pins in the H3 connector, bringing the total to 8. The 3 additional pins are not active in the regular versions of the product, but may be implemented for your application by custom programming by our engineers. Each of the 8 control outputs is separately programmable. Another custom option is “normally high” control output instead of the standard “normally low” output. With “normally high” controls the voltage level of the H3 pin is 5V until a threshold is reached, at which time it switches to 0V.

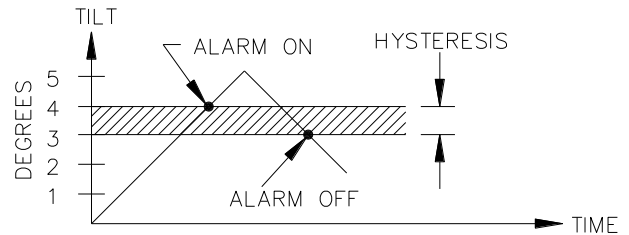

In the regular versions of **IRIS** the control pins in connector H3 are all set high for approximately 150 milliseconds on power up, after which they reset to their “normally low” value of 0V until a tilt threshold is detected.

### Connector Pinout Tables

H1 Pin	Function	H2 Pin	Function
1	Power (7-28 VDC)	1	Power (7-28 VDC)
2	Ground	2	Ground
3	Tx (RS232)	3	Ground
4	Rx (RS232)	4	Reserved
5	Tx+ (RS422)	5	Reserved
6	Tx- (RS422)	6	Reserved
7	Rx- (RS422)	7	Reserved
8	Rx+ (RS422)	8	Reserved

H3 Pin	Function
1	-X tilt threshold
2	+X tilt threshold
3	-Y tilt threshold
4	+Y tilt threshold
5	Optional threshold*
6	Optional threshold*
7	Optional threshold*
8	Threshold in any direction
9	Ground
10	3.3 VDC output

\* Custom firmware only

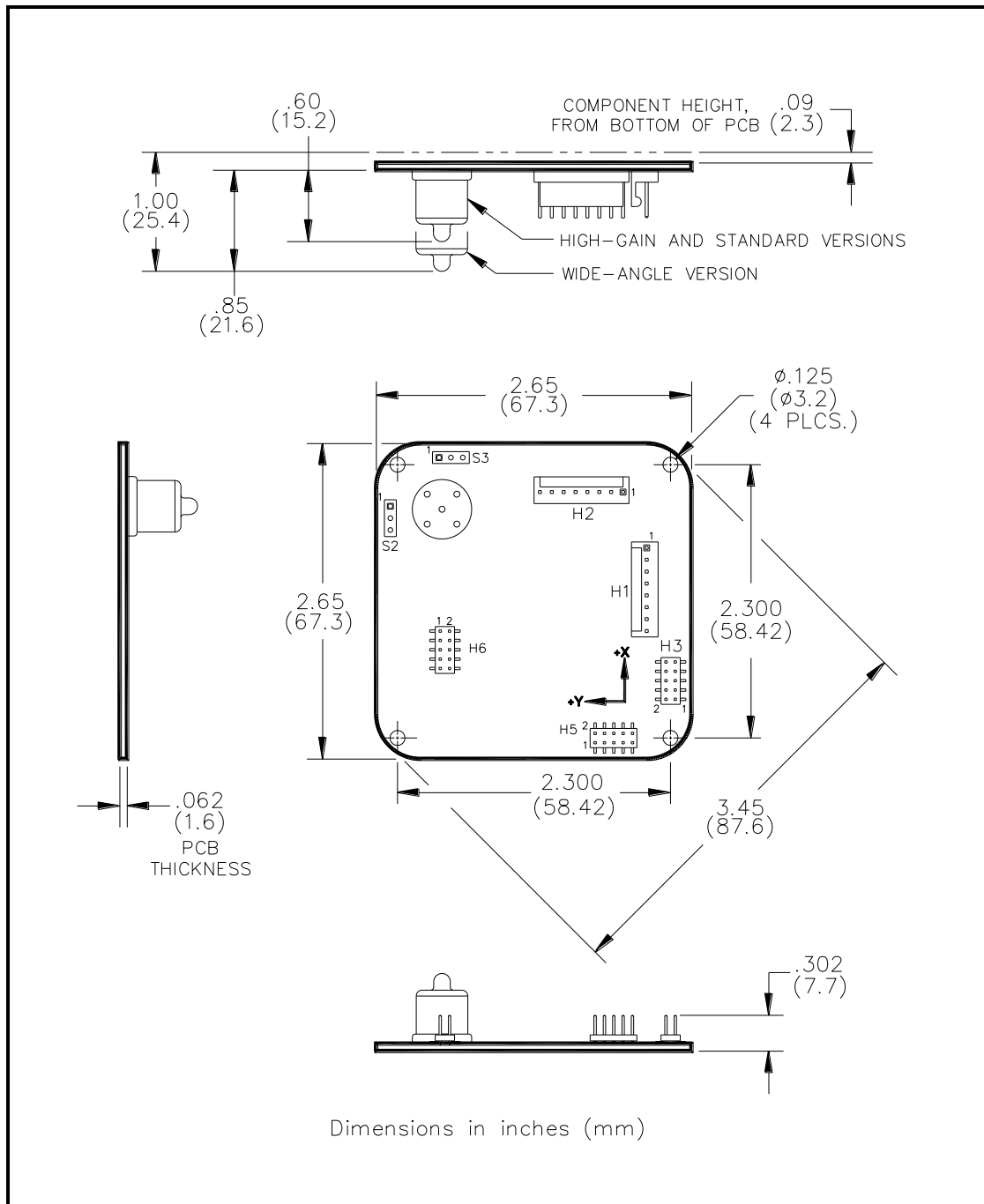

Figure 1. **IRIS** dimensions

Specifications are subject to change without notice as the result of ongoing development.

# IRIS™ Tilt Switch and Controller

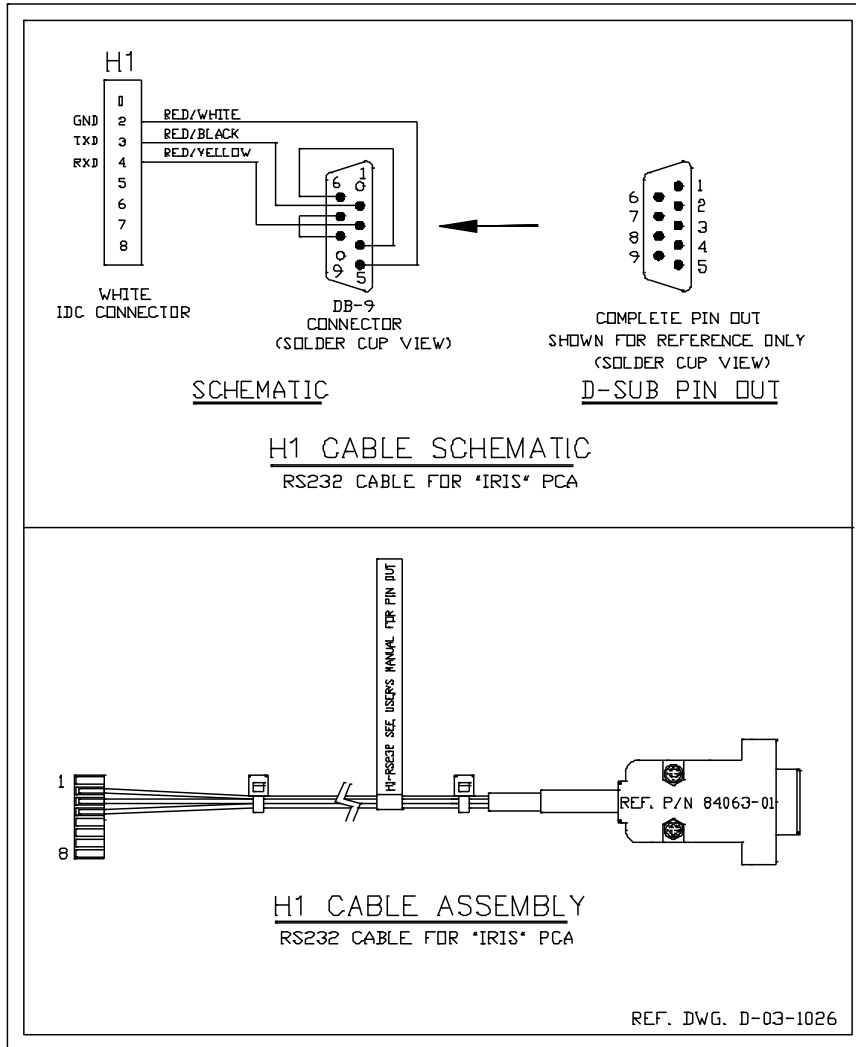

Figure 2

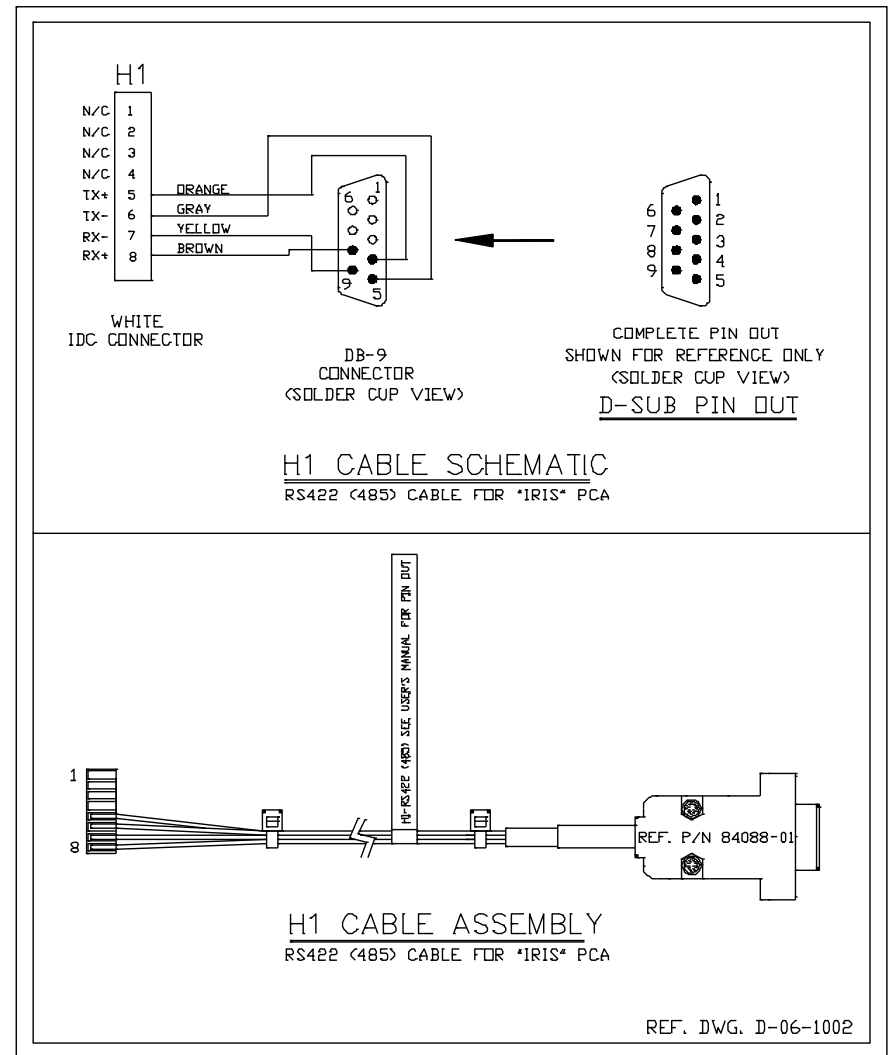

Figure 3

# IRIS™ Tilt Switch and Controller

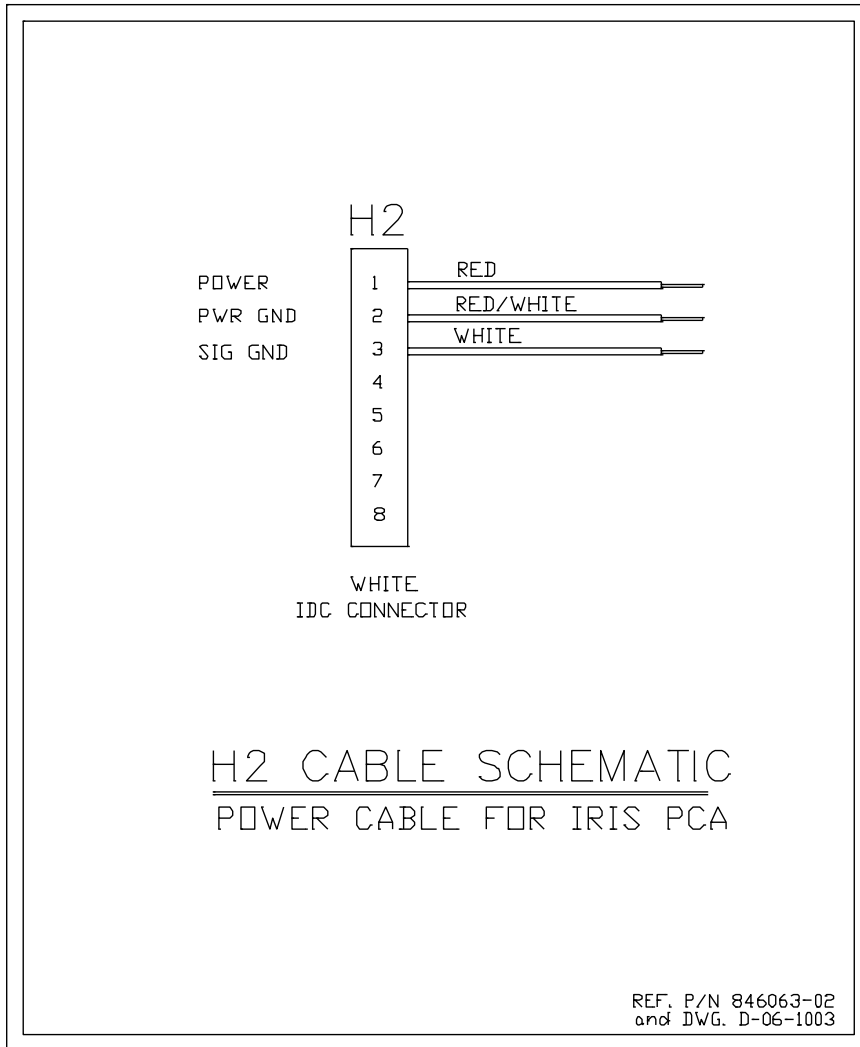

Figure 4

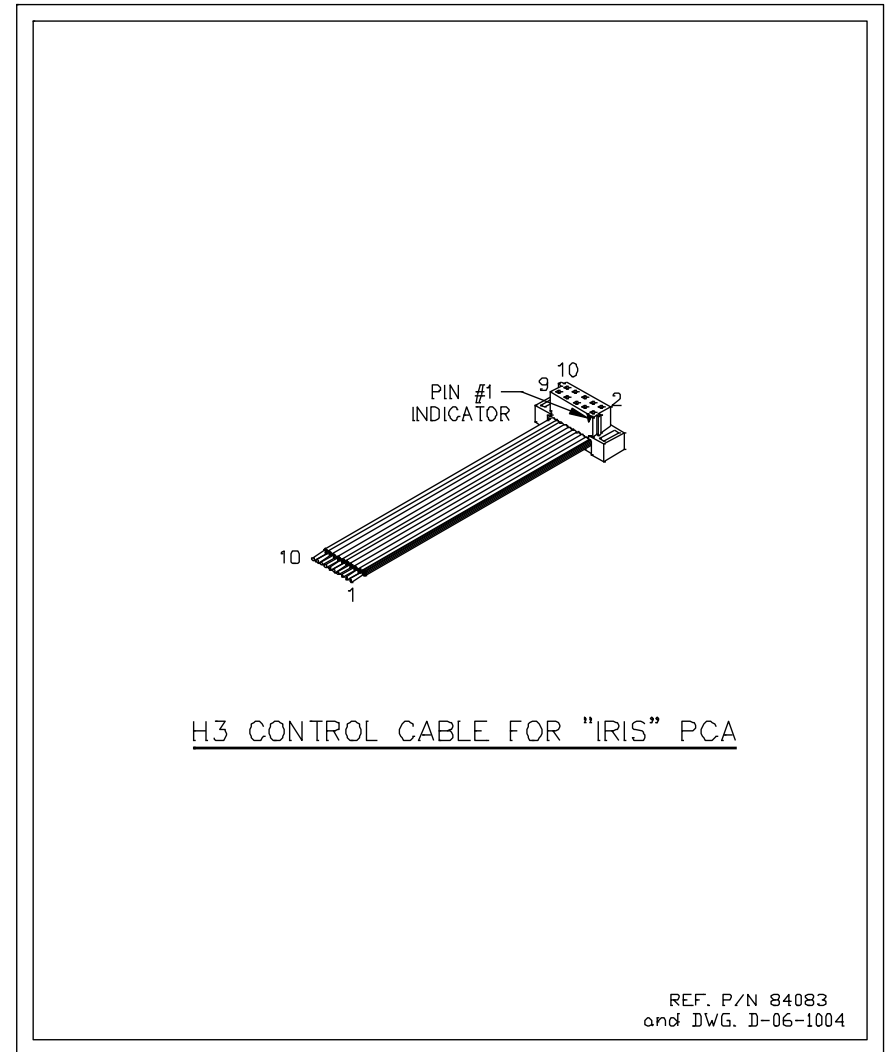

Figure 5

# IRIS™ Tilt Switch and Controller

## NOTES: UNLESS OTHERWISE SPECIFIED

- REQUIRED FIRMWARE 5.2B OR LATER. SEE 79131-01 FOR FIRMWARE REVISION HISTORY.
- SET TO OUTPUT ON POWER UP (\*9900XYC0<ENTER>).
- TURN CONTROL FUNCTION ON WITH: \*9900XY-SET-CTRL-ON,<ENTER> AND OFF WITH: \*9900XY-XY-SET-CTRL-OFF<ENTER>
- SET THRESHOLDS WITH: \*9900XY-SET-THRESHOLD,x+,x-,y+,y-<ENTER>. (I.E. x+=5.0) AND UNITS ARE THE CURRENT OUTPUT UNITS (DEFAULT IS DEGREES).
- SET HYSTERESIS WITH: \*9900XY-SET-HYST,k<ENTER> WHERE k IS IN THE CURRENT OUTPUT UNITS (DEFAULT IS DEGREES). NOTE THAT HYSTERESIS k APPLIES TO ALL DIRECTIONS.

## "IRIS" PCA\*

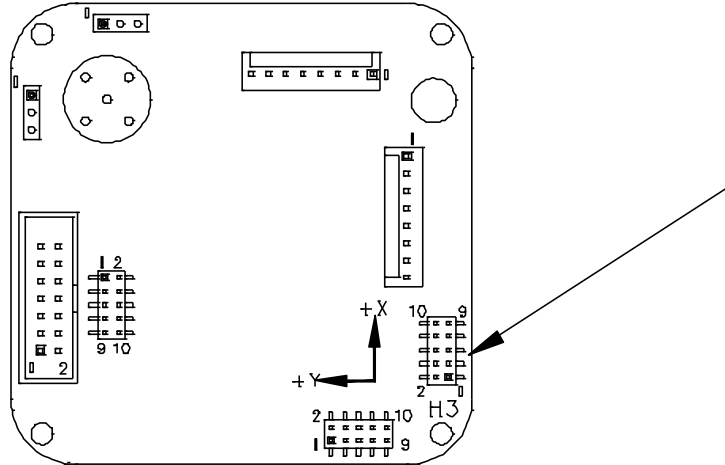

### \* "IRIS" PCA P/N LIST:

- 84841-XX
- 84842-XX
- 84843-XX
- 84844-XX

REF. DWG. 79167

## H3 PINOUT

Pin #	Function
10	3.3 VDC Output
9	Ground (Brown)
8	General Alarm* [Threshold in any direction] (Gray)
7	Unused
6	Unused
5	Unused
4	YPOS Beyond Threshold*
3	YNEG Beyond Threshold*
2	XPOS Beyond Threshold*
1	XNEG Beyond Threshold*

\* ON = 5 VDC, OFF = 0 VDC.  
Each control line will source up to 20 mA.

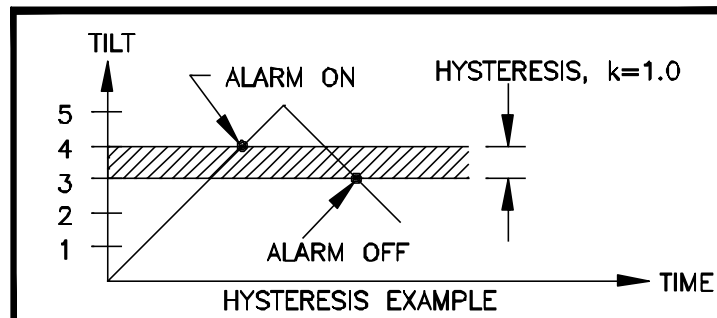

Figure 6

# ***IRIS™ Tilt Switch and Controller***

## **1 Connectors and Pinouts**

Your **IRIS** Tilt Switch and Controller uses three connectors on the printed circuit assembly: H1, H2 and H3. Pin assignments for the three connectors are shown in Figures 1-6. We have provided a short cable whip (pigtail) for each of these connectors as part of the normal IRIS product package (assembly 98021-XX). These whips include two serial cables, each terminated with a DB9 connector. One is for RS232 communications, the other for RS422(485). All serial connections are made through H1.

Power for the circuit is supplied using the power and ground pins on H1 or H2. The two grounds on H2 pins 2 and 3 are common on the **IRIS** printed circuit assembly. Pins 4-8 of H2 are reserved for new product features that are not yet implemented. *Do not connect to or short pins 4-8 of H2.*

All control functions are provided through the H3 connector. Pins 1-4 and 8 of H3 are switched outputs. H3 pin 9 (ground) is common with the ground pins in H1 and H2. For control applications we recommend the use of H3 pin 9 as ground to avoid the possibility of ground loops. H3 pins 5-7 are reserved for custom firmware versions. When using the standard firmware, *do not connect to or short pins 5-7 of H3.*

## **2 Communicating with the *IRIS* Tilt Switch and Controller**

The most common way of communicating with the **IRIS** Tilt Switch and Controller is using a terminal emulator program (e.g. Terminal in Windows 3.1 or HyperTerminal in Windows 95 and later). All communication are performed through the send (transmit) and receive wires of the serial port. The default parameters for the serial port are set to no parity, 8 bits and 1 stop bit with no hardware or software flow control. The baud rate is the only parameter that is user-selectable. The default baud rate is 9600. Baud rates up to 230400 are supported.

### **1.1 *Firmware Command Format***

The format of commands issued by the host is:

\*9900<command><CR><LF>

Valid commands are listed in Section 3.

The input/output processing on the serial port of the IRIS circuit is as follows:

- (1) Input is read until a <CR> or <LF> (carriage return or line feed) is received. (On a PC, this usually means pressing the 'Enter' or 'Return' key.)
- (2) When a line is received, it is parsed to see if it is a command of the device. If it is not, then it is echoed back out, terminated with a <CR> <LF> and we go back to step (1). All strings that are not commands for the unit are echoed. If the command is for the device, we then go to step (3).
- (3) The command is processed and we return to step (1). All incoming characters are buffered (up to 1000) while the command is being processed. If the command is for ID 99 and echoing of 99



## **IRIS™ Tilt Switch and Controller**

commands is enabled, the command is echoed after the command result is transmitted.

Default output of the MD900-T running firmware version 5 and up is a simple (“SIM”) comma-delimited string consisting of X tilt in degrees, Y tilt in degrees, temperature in °C, and the serial number of the device. Optional outputs consist of a Trimble Navigation proprietary ASCII string with X (Roll) and Y (Pitch) tilts in degrees, and two output formats that follow NMEA Standard 0183, version 2.1, October 15, 1995. This standard may be obtained from:

National Marine Electronics Association (NMEA)  
National Office  
P.O. Box 3435  
New Bern, NC 28564-3435 USA  
Tel: 919/638-2626  
Fax: 919/638-4885

### **1.2 Firmware Command Summary**

The list below summarizes the most important user-accessible firmware commands. Precede these commands with the string \*9900. See Appendix A for additional details.

XY	Outputs a single tilt and temperature measurement. The format of the output depends on the setting of the SO command.
SO-xxx	Selects the output format for the XY command. “xxx” selects format as follows:  ASH: Ashtech compatible NMEA format SIM: Simple x,y,t,sn output string (default) XDR: NMEA XDR format TCM: Trimble Navigation proprietary pitch (Y) and roll (X) string BAE: BAE Systems encoded 11-byte string containing a sync packet, x, y, t, SN, and checksum information. Advanced users only—typically for embedded system integration.
XY-MEMS	Stores tiltmeter readings at selected output rate in nonvolatile memory. (Versions 5.1 and higher)
XY-MEMD	Downloads data from nonvolatile memory. (Versions 5.1 and higher)
XY-M1	Sets the tiltmeter to Mode-1 operation.
XYVR	Displays the sign-on string.
ID	Sets the ID of units in the daisy chain (not currently implemented).
XY-TR-PASH-ON	Translates the Paros provided \$PASHS,XDR,P sentences to standard NMEA XDR format.
XY-TR-PASH-OFF	Turns off translation of \$PASHS,XDR,P sentences.

## ***IRIS™ Tilt Switch and Controller***

XY-EP	Enables power on message.																						
XY-SP	Disables power on message.																						
XY-EE	Enables echoing of global 99 commands.																						
XY-SE	Disables echoing of global 99 commands.																						
XY-SET-BAUDRATE, <i>x</i>	Sets baud rate to value of <i>x</i> in bits per second. Selectable values include 9600, 19200, 28800, 57600, 115200 and 230400 baud.																						
XY-SET-N-SAMP, <i>x</i>	Sets number of samples that are averaged before a reading is transmitted; <i>x</i> may have any value from 1 to 1000. Changing this value may also change the output rate.																						
XY-SET-RSMODE, <i>x</i>	Selects serial output mode: <i>x</i> = 0      RS232 <i>x</i> = 1      RS485 (RS422)																						
XY-AUTOZ	Turns on auto zero function.																						
XY-AUTOZOFF	Turns off auto zero function.																						
XYC <i>x</i>	Continuously sends XY data where <i>x</i> determines output rate as follows:  <table><tr><td><i>x</i> = 0:</td><td>8-10 outputs per second</td></tr><tr><td><i>x</i> = 1:</td><td>4 outputs per second</td></tr><tr><td><i>x</i> = 2:</td><td>1 output per second (default)</td></tr><tr><td><i>x</i> = 3:</td><td>1 output every 10 seconds</td></tr><tr><td><i>x</i> = 4:</td><td>1 output every 60 seconds</td></tr><tr><td><i>x</i> = 5:</td><td>1 output every hour</td></tr><tr><td><i>x</i> = 6:</td><td>1 output every 12 hours</td></tr><tr><td><i>x</i> = 7:</td><td>1 output every 24 hours</td></tr><tr><td><i>x</i> = 0A:</td><td>Averaging of the 8-10 outputs per second data</td></tr><tr><td><i>x</i> = 1A:</td><td>Averaging of the 4 outputs per second data</td></tr><tr><td><i>x</i> = 2A or <i>x</i> = A:</td><td>Averaging of the 1 output per second data</td></tr></table> Once initiated, continuous output remains in effect until turned off with the XYC-OFF command (see below).	<i>x</i> = 0:	8-10 outputs per second	<i>x</i> = 1:	4 outputs per second	<i>x</i> = 2:	1 output per second (default)	<i>x</i> = 3:	1 output every 10 seconds	<i>x</i> = 4:	1 output every 60 seconds	<i>x</i> = 5:	1 output every hour	<i>x</i> = 6:	1 output every 12 hours	<i>x</i> = 7:	1 output every 24 hours	<i>x</i> = 0A:	Averaging of the 8-10 outputs per second data	<i>x</i> = 1A:	Averaging of the 4 outputs per second data	<i>x</i> = 2A or <i>x</i> = A:	Averaging of the 1 output per second data
<i>x</i> = 0:	8-10 outputs per second																						
<i>x</i> = 1:	4 outputs per second																						
<i>x</i> = 2:	1 output per second (default)																						
<i>x</i> = 3:	1 output every 10 seconds																						
<i>x</i> = 4:	1 output every 60 seconds																						
<i>x</i> = 5:	1 output every hour																						
<i>x</i> = 6:	1 output every 12 hours																						
<i>x</i> = 7:	1 output every 24 hours																						
<i>x</i> = 0A:	Averaging of the 8-10 outputs per second data																						
<i>x</i> = 1A:	Averaging of the 4 outputs per second data																						
<i>x</i> = 2A or <i>x</i> = A:	Averaging of the 1 output per second data																						
XYC-OFF	Turns off XYC mode.																						
XY-SET-CTRL-ON	Enables control feature.																						
XY-SET-CTRL-OFF	Disables control feature.																						
XY-SET-CTRLTEST-ON	Sets the control pin high (+5 VDC).																						
XY-SET-CTRLTEST-OFF	Sets the control pin low (0 VDC).																						

## ***IRIS™ Tilt Switch and Controller***

XY-SET-THRESHOLD, $x+$ , $x-$ , $y+$ , $y-$	Sets the control thresholds. The reference angle for threshold measurement is selected using the XY-AUTOZ command.
XY-SET-HYST, $k$	Sets the control hysteresis.
XY-DUMP-SETTINGS	Dumps settings of device.
XY-DUMP2	Dumps extended settings of device.

## **2 Setting the Control Thresholds**

The firmware commands for turning the control feature of **IRIS** on and off, and for setting the control thresholds (set points) are summarized in Figure 6 and in Section 1.2. They are described in greater detail in Section 4. The reference angle for each control threshold is the zero angle, as set by the autozero command, XY-AUTOZ. If the unit is not autozeroed, the reference angle is the zero angle set during the instrument's factory calibration.

If you plan to rotate **IRIS** in the X or Y direction only, set the positive and negative X and Y thresholds using the XY-SET-THRESHOLD, $x+$ , $x-$ , $y+$ , $y-$  command. If you need to detect a tilt threshold in any direction (not just the X or Y direction), set the “General Alarm” threshold (H3 pin 8, Figure 6) in the following manner:

Set  $x+$  =  $y+$  (a positive number)  
Set  $x-$  =  $y-$  (a positive or a negative number)

When  $tilt > x+$ , pin H3-8 goes high.  
When  $tilt < x-$  and  $x- > 0$ , pin H3-8 goes high.

When  $x- \leq 0$ , only the positive threshold is used for the “General Alarm”.

Hysteresis (Figure 6) is applied to all thresholds in the same manner. Set the hysteresis using the XY-SET-HYST, $k$  command.



**Caution:** *Always verify that your control thresholds are functioning as intended before using your IRIS Tilt Switch & Controller in critical applications. Jewell Instruments LLC shall not be liable for any direct, indirect, special, incidental or consequential damages!*

## **3 Sample Data Using the XY Command**

When you use your IRIS circuit to collect tilt data, the most commonly used command is the XY command, which returns the X and Y tilt angles in degrees and the internal temperature of the MD900-T in °C. The format of the returned data depends on the setting of the SO command. The returned data are averages of a series of readings. The number of samples used in the average is set by the XY-SET-N-SAMP command. The following lines illustrate the format of the data returned by the XY command for the range of possible SO settings:

SO = “ASH.” Ashtech compatible NMEA output string which returns the North-South (Y) and East-West (X) tilt angle in degrees and the internal temperature of the MD-900-T in °C:

## **IRIS™ Tilt Switch and Controller**

\$PASHS,XDR,A,004.261,D,N,A,004.280,D,E,C,021.288,C,T-N1346  
\$PASHS,XDR,A,004.261,D,N,A,004.280,D,E,C,021.306,C,T-N1346  
\$PASHS,XDR,A,004.261,D,N,A,004.280,D,E,C,021.298,C,T-N1346  
\$PASHS,XDR,A,004.261,D,N,A,004.280,D,E,C,021.332,C,T-N1346

SO = “SIM” (default). Simple X,Y,T,SN output which returns the X and Y tilt angle in degrees and the internal temperature of the MD-900-T in °C:

\$-00.619,000.023,018.910,N0000  
\$-00.619,000.023,018.923,N0000  
\$-00.620,000.024,018.932,N0000  
\$-00.620,000.023,018.951,N0000

SO = “XDR.” Standard NMEA XDR output string which returns the North-South (Y) and East-West (X) tilt angle in degrees and the internal temperature of the MD-900-T in °C:

\$YXXDR,A,000.034,D,N,A,-00.625,D,E,C,021.651,C,T-N0000\*47  
\$YXXDR,A,000.034,D,N,A,-00.624,D,E,C,021.675,C,T-N0000\*40  
\$YXXDR,A,000.034,D,N,A,-00.624,D,E,C,021.686,C,T-N0000\*4C  
\$YXXDR,A,000.034,D,N,A,-00.625,D,E,C,021.707,C,T-N0000\*45

SO = “TCM.” Proprietary Trimble Navigation pitch (Y-tilt) and roll (X-tilt) output string which returns the tilt angle in degrees and a checksum:

\$P-00.907R002.186\*1C  
\$P-00.906R002.183\*18  
\$P-00.908R002.191\*15  
\$P-00.908R002.191\*15  
\$P-00.905R002.190\*19

SO = “BAE.” Advanced users only, using the D711-2A(4X). BAE Systems encoded 11-byte output which returns two synchronization bytes, the X (2 bytes) and Y (2 bytes) tilt angle, the internal temperature of the tiltmeter (2 bytes), the serial number (2 bytes), and a checksum byte:

U<sup>a</sup> Ä\$é TæU<sup>a</sup> Ä\$ä TãU<sup>a</sup> Ä\$ß TÛU<sup>a</sup> Ä\$é Tæ

The BAE output string is not clearly decipherable by HyperTerminal, which sometimes hides characters that it has received and cannot understand. Because of this, it is difficult, if not impossible, to interpret data in this format. The above output string shows four outputs taken from HyperTerminal. This encoded output command is typically used to communicate with embedded systems, as they can view raw data and perform fast translations.

The first synchronization byte is 0x55, the second is 0xAA. The X and Y bytes use 0.0000277 angular degrees per LSB, hence the total output range of this output mode is limited to the model D711-2A(4X). The temperature uses 0.004 degrees Celsius per LSB. The serial number is a two byte integer. The checksum byte is the result of ANDing bytes 2-7 with 255.

## IRIS™ Tilt Switch and Controller

BAE output mode reduces the total number of characters per output to 11 bytes, while transferring the same data as the SIM output mode, which requires 33 bytes. BAE mode also includes checksum and frame synchronization bytes. Refer to Appendix A, Firmware Commands, to decode the output.

### 4 Firmware Commands

Valid commands are listed below. Some commands have more than one string to trigger the command. “t” stands for the target ID (99) and “ss” stands for the source ID (00). Settings stored in nonvolatile memory remain in effect until disabled, even after a power cycle.

```
-----
XY      Outputs a single tilt measurement. The format of the output
       depends on the setting of the SO command.

       Syntax: *ttssXY<CR><LF>

       Error Strings: None.

       Default: N/A

       Persistence: N/A

       Example:
       command: *9900XY<CR><LF>
       response: $YXXDR,A,-00.920,D,N,A,-00.210,D,E,C,030.045,C,T-N1212*57
-----
```

```
SO      Selects the output format for the XY command. The possible formats
       are:

       -SIM
           $x.x,y.y,t.t,sn<CR><LF>
           |   |   |   |
           |   |   |   | Serial number
           |   |   |   | Temperature of tiltmeter
           |   |   |   | Y-tilt value in degrees
           |   |   |   | X-tilt value in degrees
       Example:
       $-00.920,-00.210,030.045,N1212

       -XDR
           $YXXDR,A,x.x,D,N,A,x.x,D,E,C,x.x,C,T-sn*hh<CR><LF>
           |   |   |   |   |   |   |   |   |   |   |   |   |
           |   |   |   |   |   |   |   |   |   |   |   |   | Checksum
           |   |   |   |   |   |   |   |   |   |   |   |   | Serial number
           |   |   |   |   |   |   |   |   |   |   |   |   | Comment, T for temperature
           |   |   |   |   |   |   |   |   |   |   |   |   | Units, C=degrees C
           |   |   |   |   |   |   |   |   |   |   |   |   | Temperature of tiltmeter
           |   |   |   |   |   |   |   |   |   |   |   |   | Data Type, C=Temperature
           |   |   |   |   |   |   |   |   |   |   |   |   | Comment, E for East/West (X) direction
           |   |   |   |   |   |   |   |   |   |   |   |   | Units, M=microradians, D=degrees
           |   |   |   |   |   |   |   |   |   |   |   |   | X (E)-tilt value
           |   |   |   |   |   |   |   |   |   |   |   |   | Data Type, A=Angular
           |   |   |   |   |   |   |   |   |   |   |   |   | Comment, N for North/South (Y) direction
           |   |   |   |   |   |   |   |   |   |   |   |   | Units, M=microradians, D=degrees,
           |   |   |   |   |   |   |   |   |   |   |   |   | Y (N)-tilt value
           |   |   |   |   |   |   |   |   |   |   |   |   | Data Type, A=Angular
       Example:
       $YXXDR,A,-00.920,D,N,A,-00.210,D,E,C,030.045,C,T-N1212*57
-----
```



## **IRIS™ Tilt Switch and Controller**

-----  
XY-MEMS Stores the tiltmeter readings in simple format (SO-SIM) at selected output rate in nonvolatile memory.

Syntax: \*ttssXY-MEMS<CR><LF>

Error Strings: None.

Default: N/A

Persistence: Subsequent tiltmeter readings stored in nonvolatile memory until memory is full. Maximum of approximately 150 lines of data.

Example:

command: \*9900XY-MEMS<CR><LF>

response: <none>

-----  
XY-MEMD Downloads the tiltmeter readings in nonvolatile memory to PC.

Syntax: \*ttssXY-MEMD<CR><LF>

Error Strings: None.

Default: N/A

Persistence: Stored tiltmeter readings downloaded at rate of 1 per second to PC in ASCII comma-delimited string.

Example:

command: \*9900XY-MEMD<CR><LF>

response: \$start:11-11-1997 18:43:09 4/sec  
\$000.699,-01.022,025.116,N1028  
\$000.699,-01.022,025.116,N1028  
\$000.698,-01.021,025.110,N1028  
\$000.698,-01.022,025.122,N1028

-----  
XY-M1 Sets the operation to Mode 1. This command groups several other commands together for convenience. The commands that are issued are:

XY-TR-PASH-ON

XY-SO-XDR

XY-SE

XY-SP

Syntax: \*ttssXY-M1<CR><LF>

Error Strings: None.

Default: N/A

Persistence: Setting is stored in nonvolatile memory.

Example:

command: \*9900XY-M1<CR><LF>

response: AGI Model D711-2A(4X) Firmware V2.2 SN-N1212 ID01

## ***IRIS™ Tilt Switch and Controller***

-----  
XYVR Displays the sign-on string.

Syntax: \*ttssXYVR<CR><LF>

Error Strings: None.

Default: N/A

Persistence: N/A

Example:

command: \*9900XYVR<CR><LF>

response: AGI Model D711-2A(4X) Firmware V5.2 SN-N1212 ID01

-----  
ID *This command is not currently supported.* Sets the ID of units in the daisy chain. The first device in the serial chain sets its ID to the source ID plus one (ss+1), and then outputs a the ID command to the next device with the source ID set to its new ID. The target ID of this command must be 99.

Syntax: \*99ssID<CR><LF>

Error Strings: None.

Default: 01

Persistence: Setting is stored in nonvolatile memory.

Example:

command: \*9900ID<CR><LF>

response: \*9901ID<CR><LF>

-----  
XY-TR-PASH-ON Translates the Paros provided \$PASHS,XDR,P sentences to standard NMEA XDR format. An example input PASH string would be:

\$PASHS,XDR,P,1.000123,B,SN123,C,22.12,C,SN123,H,32.11,P,SN123<CR><LF>

The translated string would then be:

\$WIXDR,P,1.000123,B,SN123,C,22.12,C,SN123,H,32.11,P,SN123\*hh<CR><LF>

Syntax: \*ttssXY-TR-PASH-ON<CR><LF>

Error Strings: None.

Default: Off.

Persistence: Setting is stored in nonvolatile memory.

Example:

command: \*9900XY-TR-PASH-ON<CR><LF>

response: <none>



## ***IRIS™ Tilt Switch and Controller***

-----  
XY-TR-PASH-OFF Turns off translation of \$PASHS,XDR,P sentences.

Syntax: \*ttssXY-TR-PASH-OFF<CR><LF>

Error Strings: None.

Default: N/A

Persistence: Setting is stored in nonvolatile memory.

Example:

command: \*9900XY-TR-PASH-OFF<CR><LF>

response: <none>

-----  
XY-EP Enables power on message. Power on message is:  
AGI Tiltmeter Firmware V5.2 SN-N1212 ID01  
Where V5.2 is the firmware version, SN-N1212 is the serial  
number of the device and ID01 is the target's ID.

Syntax: \*ttssXY-EP<CR><LF>

Error Strings: None.

Default: On.

Persistence: Setting is stored in nonvolatile memory.

Example:

command: \*0100XY-EP<CR><LF>

response: <none>

-----  
XY-SP Disables power on message.

Syntax: \*ttssXY-SP<CR><LF>

Error Strings: None.

Default: N/A

Persistence: Setting is stored in nonvolatile memory.

Example:

command: \*9900TR-SP<CR><LF>

response: <none>

-----  
XY-EE Enables echoing of global 99 commands. If the unit receives  
a command for ID 99, then the unit will respond to the command  
and echo the command when it is done.

Syntax: \*ttssXY-EE<CR><LF>

Error Strings: None.

Default: On.

Persistence: Setting is stored in nonvolatile memory.

Example:

command: \*0100XY-EE<CR><LF>

response: <none>

## ***IRIS™ Tilt Switch and Controller***

-----  
XY-SE Disables echoing of global 99 commands. If the unit receives a command for ID 99, then the unit will respond, but the unit will NOT echo the command when it is done.

Syntax: \*ttssXY-SE<CR><LF>

Error Strings: None.

Default: N/A

Persistence: Setting is stored in nonvolatile memory.

Example:

command: \*0100XY-SE<CR><LF>

response: <none>

-----  
XY-SET-BAUDRATE,x Changes communications baud rate. Maximum supported baud rate is 57,600 baud. The parameter x is an integer with up to six places, defining the baud rate as follows:

9600 = 9600 baud  
19200 = 19200 baud  
28800 = 28800 baud  
57600 = 57600 baud  
115200 = 115200 baud  
230400 = 230400 baud

Syntax: \*ttssXY-SET-BAUDRATE,x<CR><LF>

Error Strings: ERR XY-SET-BAUDRATE,x PARSE ERROR.

Default: 9600

Persistence: Setting is stored in nonvolatile memory.

Example:

command: \*9900XY-SET-BAUDRATE,57600<CR><LF>

response: <none>

-----  
XY-SET-N-SAMP,x Sets the number of samples that are averaged before a reading is transmitted. The parameter x is an integer between 1 and 1000 equal to the number of samples that are averaged.

Syntax: \*ttssXY-SET-N-SAMP,x<CR><LF>

Error Strings: None.

Default: Depends on data output rate, as specified by the XYCx command.

The default numbers of samples averaged for each data rate are:

XYC0: 28  
XYC1: 100  
XYC2: 460  
XYC3: 500  
XYC4: 500  
XYC5: 500  
XYC6: 500  
XYC7: 500

If the number of samples specified exceeds the number listed above for XYC0, XYC1 or XYC2, the microprocessor reduces the data output rate until it has enough time to collect and average all of the samples.

## **IRIS™ Tilt Switch and Controller**

Persistence: Once initiated, the same averaging remains in effect even with power cycle. (Setting is stored in nonvolatile memory.) Can be changed by reissuing the command with a different value for x, or by changing the output rate with the XYCx command.

Example:  
command: \*9900XY-SET-N-SAMP,250<CR><LF>  
response: <none>

-----  
XY-SET-RSMODE,x      Sets output protocol to RS232 or RS485(RS422), as follows:

x = 0: RS232  
x = 1: RS485(RS422)

Syntax: \*ttss XY-SET-RSMODE,x<CR><LF>

Error Strings: None.

Default: Set in factory to customer specification.

Persistence: Once initiated, remains in effect even with power cycle. (Setting is stored in nonvolatile memory.)

Example:  
command: \*9900XY-SET-RSMODE,0<CR><LF>  
response: <none>

**CAUTION:** If you change the output protocol, you will no longer be able to communicate with the tiltmeter unless you have the correct interconnect cable.

-----  
XY-AUTOZ            Turns autozero function on, causing tiltmeter to subtract current X and Y readings from all subsequent X and Y readings.

Syntax: \*ttssXY-AUTOZ <CR><LF>

Error Strings: None.

Default: Off.

Persistence: Setting is stored in nonvolatile memory.

Example:  
command: \*9900XY-AUTOZ<CR><LF>  
response: <none>

-----  
XY-AUTOZOFF        Turns autozero function off, causing tiltmeter to display non-biased (unshifted) position readings.

Syntax: \*ttssXY-AUTOZ-OFF<CR><LF>

Error Strings: None.

Default: Off.

Persistence: Setting is stored in nonvolatile memory.

Example:  
command: \*9900XY-AUTOZ-OFF<CR><LF>  
response: <none>

## **IRIS™ Tilt Switch and Controller**

-----  
XYCx Continuously sends XY data - even after power has been turned off and then on again. Timing is determined by the microprocessor's crystal and is approximate. The parameter x is an integer between 1 and 7, the letter A, or 0A, 1A, or 2A.

An A indicates the use of the moving average function, in which the moving average of the data is output. When the moving average function is used, the first output is delayed until the first n readings have been taken, where n is the number of readings to be averaged. After that, the outputs occur at the same rate as the readings. For example, the command XYC2A outputs the moving average of the same data that would be output if the user issued the command XYC2. Since XYC2 outputs data once per second, XYC2A also outputs once per second. However, the first output occurs after a four-second delay, in which the first four readings (at a rate of 1 per second) are averaged. The second output is the average of readings 2-5, the third output is the average of readings 3-6, and so on, creating an output rate equal to that of XYC2.

The parameter x determines rate of continuous output as follows:

x = 0: 8-10 per second  
1: 4 per second  
2: 1 per second  
3: 1 every 10 seconds  
4: 1 every 60 seconds  
5: 1 every 60 minutes  
6: 1 every 12 hours  
7: 1 every 24 hours  
0A: Average of 8-10 outputs/sec data. 10 readings are averaged.  
1A: Average of 4 outputs/second data. 4 readings are averaged.  
2A or A: Average of 1 output/second data. 4 readings are averaged.

Syntax: \*ttssXYCx<CR><LF>

Error Strings: None.

Default: Off.

Persistence: Once initiated, continuous output remains in effect even with power cycle. (Setting is stored in nonvolatile memory.) Must be turned off using the XYC-OFF command (see below).

Example (with SO="SIM"):  
command: \*9900XYC1<CR><LF>  
response: \$-00.699,000.070,020.290,N0000  
          \$-00.699,000.071,020.309,N0000  
          \$-00.699,000.071,020.313,N0000  
          \$-00.699,000.071,020.330,N0000  
          \$-00.699,000.071,020.348,N0000  
          \$-00.700,000.070,020.360,N0000

-----  
XYC-OFF Turns off XYC mode.

Syntax: \*ttssXYC-OFF<CR><LF>

Error Strings: None.

Default: N/A.

Persistence: Setting is stored in nonvolatile memory.

Example:  
command: \*0100XYC-OFF<CR><LF>  
response: \*0100XYC-OFF<CR><LF>

## ***IRIS™ Tilt Switch and Controller***

-----  
XY-SET-CTRL-ON      Enables control feature. If the tilt exceeds either threshold in any direction, the control pin will go high (+5 VDC) until the tilt falls below the positive threshold value minus the hysteresis value, or falls above the negative threshold value plus the hysteresis value.

Syntax: \*ttssXY-SET-CTRL-ON<CR><LF>

Error Strings: None.

Default: On.

Persistence: Setting is stored in nonvolatile memory.

Example:

command: \*9900XY-SET-CTRL-ON<CR><LF>

response: <none>

-----  
XY-SET-CTRL-OFF      Disables control feature. The control pin will remain at ground potential (0 VDC) unless the user issues the command XY-SET-CTRLTEST-ON or turns the control feature on again by issuing the command XY-SET-CTRL-ON.

Syntax: \*ttssXY-SET-CTRL-OFF<CR><LF>

Error Strings: None.

Default: On.

Persistence: Setting is stored in nonvolatile memory.

Example:

command: \*9900XY-SET-CTRL-OFF<CR><LF>

response: <none>

-----  
XY-SET-CTRLTEST-ON      Sets the control pin high (+5 VDC), regardless of whether control feature is on or off. Convenient for testing control functionality regardless of tilt.

Syntax: \*ttssXY-SET-CTRLTEST-ON<CR><LF>

Error Strings: None.

Default: Off.

Persistence: Control pin stays high until the user issues the command XY-SET-CTRLTEST-OFF or disconnects power.

Example:

command: \*9900XY-SET-CTRLTEST-ON<CR><LF>

response: <none>

## **IRIS™ Tilt Switch and Controller**

-----  
XY-SET-CTRLTEST-OFF Sets the control pin low (0 VDC). If the control feature is on and the tilt falls above the positive threshold value minus the hysteresis value, or falls below the negative threshold value plus the hysteresis value, the control pin may go high again immediately. XY-SET-CTRL-OFF turns off the control feature altogether.

Syntax: \*ttssXY-SET-CTRLTEST-OFF<CR><LF>

Error Strings: None.

Default: Off.

Persistence: None. If the control feature is on and the tilt exceeds the hysteresis value, the control pin may go high again immediately.

Example:

command: \*9900XY-SET-CTRLTEST-OFF<CR><LF>

response: <none>

-----  
XY-SET-THRESHOLD,x+,x-,y+,y- Sets the control thresholds. The parameter x+ is the positive threshold for the x axis in the current output units (default is degrees), and so on for parameters x-, y+, and y-. If the tilt exceeds either threshold on either axis, and the control feature is on, the control pin goes high (+5 VDC) until the tilt falls below the positive threshold value minus the hysteresis value, or falls above the negative threshold value plus the hysteresis value.

Syntax: \*ttssXY-SET-THRESHOLD,x+,x-,y+,y-<CR><LF>

Error Strings: ERR XY-SET-THRESHOLD PARSE ERROR.

Default:    x+ = 1  
          x- = -1  
          y+ = 1  
          y- = -1

Persistence: Setting is stored in nonvolatile memory.

Example:

command: \*9900XY-SET-THRESHOLD,5,-3.244,4.0,0<CR><LF>

response: <none>

## **IRIS™ Tilt Switch and Controller**

-----  
XY-SET-HYST,x        Sets the control hysteresis, where the parameter x is the hysteresis value in the current output units (default is degrees). If the tilt exceeds either threshold on either axis, and the control feature is on, the control pin remains high (+5 VDC) until the tilt falls below the positive threshold value minus the hysteresis value, or falls above the negative threshold value plus the hysteresis value.

Syntax:    \*ttssXY-SET-HYST,x<CR><LF>

Error Strings:    ERR XY-SET-HYST PARSE ERROR.

Default:    0

Persistence:    Setting is stored in nonvolatile memory.

Example:  
command:    \*9900XY-SET-HYST,0.5<CR><LF>  
response:    <none>

-----  
XY-DUMP-SETTINGS        Dumps settings of device.

Syntax:    \*ttssXY-DUMP-SETTINGS<CR><LF>

Error Strings:    None.

Default:    N/A

Persistence:    N/A

Example:  
command:    \*9900XY-DUMP-SETTINGS  
response:

```
APPLIED GEOMECHANICS Tiltmeter        Firmware V5.0 SN-N2144 ID01
01: Vbias= 2047.000000000 2047.000000000 NaN                NaN
01: Vgain=    0.005000000    0.005000000    0.000610350    0.000610350
01: Vmin:  -2.50  -2.50    2.50    2.50
01: Vmax:    2.50    2.50    2.50    2.50
01: a0=    0.00000    0.00000    0.00000    0.00000    0.00000    0.00000
01: a1=    0.00000    0.00000    0.00000    0.00000    0.00000    0.00000
01: a2=    0.00000    0.00000    0.00000    0.00000    0.00000    0.00000
01: a3=    0.00000    0.00000    0.00000    0.00000    0.00000    0.00000
01: Tcoef 0: Ks=        0.0003 Kz=                0 Tcal=                25
01: Tcoef 1: Ks=        0.0003 Kz=                0 Tcal=                25
01: N_SAMP=1000 Xzero=    0.00 Yzero=    0.00
01: TR-PASH-OFF E99-ON    SO-NMEA-SIM XY-EP    9600 baud FV-
```

## ***IRIS™ Tilt Switch and Controller***

-----  
XY-DUMP2      Dumps extended settings of device.

Syntax: \*ttssXY-DUMP2<CR><LF>

Error Strings: None.

Default: N/A

Persistence: N/A

Example:

command: \*9900XY-DUMP2

response:

```
01: TBias: 8.95
Above 0.00(KZMinTemp): kz[0]=          0, kz[1]=          0.0011
Below 0.00(KZMinTemp): kz[2]=          0, kz[3]=          0.0011
01: ADCDelay: 310
01: PCA Model: 84833-13
01: Firmware Version: 5.10 Rev D
01: X Ch Gain= 1.0000, Y Ch Gain= 1.0000, Temperature Gain= 1.0000
01: Output Mode: Degrees
01: Using RS232
01: Real Time Clock: Not Installed
01: External Flash Capacity: 0 Bytes(Not Installed)
01: Relay Thresholds:
01:   Xpositive=1.0000   Xnegative=-1.0000
01:   Ypositive=1.0000   Ynegative=-1.0000
01: Calibration method: Dynamic
01: Positive Limit=1.5000   Negative Limit=-1.5000
01: Calibration Points:041 X: Disabled Y: Enabled
01: Uniaxial (x2) Sensor Type (2)
01: ADC Channels: Two
```



## 5 WARRANTY and LIMITATION of LIABILITY

Standard goods (those listed in Jewell Instruments' published sales literature, excluding software) manufactured by Jewell Instruments LLC are warranted against defects in materials and workmanship for twelve (12) months from the date of shipment from Jewell's premises with the following exceptions: Series 900 analog or digital clinometers are warranted against defects in materials and workmanship for 90 days from the delivery date. Jewell will repair or replace (at its option) goods that prove to be defective during the warranty period provided that they are returned prepaid to Jewell and:

- (a) that the goods were used at all times for the purpose for which they were designed and in accordance with any instructions given by Jewell Instruments in respect of them,
- (b) that notice is received by Jewell Instruments within 30 days of the defects becoming apparent, and
- (c) that return authorization is received from Jewell Instruments prior to the goods being sent back.

Should goods be damaged in transit to the Purchaser, Jewell will accept no liability unless the Purchaser can show that such damage arose solely from Jewell's failure to pack the goods properly for shipment.

Software products are warranted to perform substantially in accordance with their documentation for 90 days following your receipt of the software. Jewell Instruments and its suppliers do not and cannot warrant the performance or results you may obtain by using the software or its documentation.

In respect of goods or parts thereof manufactured by others and resold by Jewell, Jewell will pass on to the customer the benefit of any guarantee or warranty received by Jewell Instruments from the original manufacturer insofar as such guarantee or warranty is assignable.

ANY OTHER CONDITIONS OR WARRANTIES WHETHER EXPRESS OR IMPLIED BY STATUTE OR OTHERWISE ARE EXCLUDED. THE REMEDIES PROVIDED HEREIN ARE THE BUYER'S SOLE AND EXCLUSIVE REMEDIES. JEWELL INSTRUMENTS LLC SHALL NOT BE LIABLE FOR ANY DIRECT, INDIRECT, SPECIAL, INCIDENTAL OR CONSEQUENTIAL DAMAGES, INCLUDING LOST PROFITS OR LOST SAVINGS, WHETHER BASED ON CONTRACT, TORT, OR ANY OTHER LEGAL THEORY. THIS WARRANTY EXTENDS ONLY TO THE ORIGINAL PURCHASER AND IS EXPRESSLY IN LIEU OF ALL OTHER WARRANTIES, WHETHER OF MERCHANTABILITY OR FITNESS FOR ANY PARTICULAR USE, AND OF ALL OTHER OBLIGATIONS AND LIABILITIES OF ANY KIND AND CHARACTER. THERE ARE NO WARRANTIES WHICH EXTEND BEYOND THE DESCRIPTION ON THE FACE HEREOF.

Jewell's liability arising out of the sale of its goods is expressly limited to the repair and/or replacement of defective parts or the cost of such repair and/or replacement.

If software does not perform substantially in accordance with the documentation, the entire and exclusive liability and remedy shall be limited to either, at Jewell's option, the replacement of the software or the refund of the license fee you paid for the software.

Liability for any other form of loss or damage is hereby expressly excluded.

Customer shall indemnify Jewell Instruments against any third party claim arising out of the use of goods and/or services supplied by Jewell Instruments, including any claim arising directly or indirectly out of alleged negligence on the part of Jewell Instruments, its employees, servants, representatives or agents.

## Revision Record

REV.	PAGE NOS.	ECN NO.	DESCRIPTION OF CHANGE	DATE
B	ALL	25649	"Jewell" was "Applied Geomechanics" Added page 19 for revision record	8/19/13